



TABLES FITTINGS AND ACCESSORIES



NEW PIANO HINGES

Plated steel or Stainless Steel continuous hinge 1980mm long.

- FFPNH252 25mm open (2 x 12.5mm leaves) NICKEL PLATED
- FFPNH322 32mm open (2 x 16mm leaves) NICKEL PLATED

- FFPNH322BP 32mm open (2 x 16mm leaves) BRASS EFFECT
- FFPNH322ST 32mm open (2 x 16mm leaves) STAINLESS STEEL



New Piano Hinge



TSMN280

NEW Hinged spring up flap bracket

TSMN280 • Screw fixing • Suitable for extending tables and worktops
 • For horizontal installation • Load carrying capacity up to 30 kg per pair
 • Yellow chromatised steel

NEW CABINET HINGES

- FFCFH090 Cranked flush hinge
- FFFFH089 Flat flush hinge
- FFCFH117 Cranked flush hinge long strap

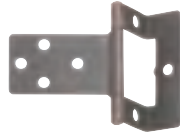

FFCFH117



FFCFH090



FFFFH089

NEW FLAT HINGES

Flat hinges in brass, ZINC plated steel or stainless steel

- FFHBF3530 35 X 30MM FLAT BRASS HINGE
- FFHBF4035 40 X 35MM FLAT BRASS HINGE
- FFHSSF3020 30 X 20MM FLAT STAINLESS HINGE
- FFHSSF5030 50 X 30MM FLAT STAINLESS HINGE
- FFHZF3022 30 X 22MM FLAT ZINC PLATED HINGE
- FFHZF4028 40 X 28MM FLAT ZINC PLATED HINGE
- FFHZF5030 50 X 30MM FLAT ZINC PLATED HINGE



FFHZFW2050



FFHZF4028



FFHSSF3020

NEW WIDE LEAF FLAT HINGES

- FFHZFW2050 20 X 50MM WIDE FLAT ZINC PLATED HINGE
- FFHZFW2270 22 X 70MM WIDE FLAT ZINC PLATED HINGE
- FFHBFW3065 30 X 65MM WIDE FLAT BRASS INSET HINGE



FFHBC4035



FFHBF4035



FFH1110 (-10,-12,-16)

NEW CRANKED HINGES

Cranked hinges in brass.

- FFHBC4035 40 X 35MM CRANKED BRASS HINGE

NEW CONCEALED BRASS HINGES

Neat hinge for inserting into end of door or flap. Length is overall of both halves of hinge.

- FFH1110-10 CONCEALED HINGE 10mm dia L=22mm
- FFH1110-12 CONCEALED HINGE 12mm dia L=28mm
- FFH1110-16 CONCEALED HINGE 16mm dia L=33mm



FFHBFW3065



FFCJTRIW



PULL OUT WARDROBE RAIL

NEW CORNER JOINTS

- FFCJTRIW TRIANGULAR CORNER JOINTS
- B6306GY CORNER JOINT DOUBLE - GREY

NEW DOOR LATCHES

- DHCHR052 LIFT FLAP DOOR LATCH SATIN NICKEL
- DHCHR053 CATCH PLATE FOR DHCHR052



DHCHR052



B6306GY

NEW PULL OUT WARDROBE RAIL

- FFPOWR260 260MM CLOSED 231 FIX CTRS 8KG MAX
- FFPOWR310 310MM CLOSED 281 FIX CTRS 6KG MAX
- FFPOWR360 360MM CLOSED 331 FIX CTRS 5KG MAX

NEW SEAT BOX TOP HINGES

95 deg opening with 110mm forward movement to account for cushion top. built in stop prevents seat top from slamming. Counterbalance sprung version will hold max 8kg seat top open.

- FFSBTHSP SPRING SEATBOX TOP HINGES PAIR BURNISHED
- FFSBTH SEATBOX TOP HINGES PAIR GALVANISED YELLOW



FFSBTH



FFSBTHSP

HARDWOOD BED SLATS

• High strength beech slats as used by all the leading manufacturers. 53 X 8 mm profile.

- FBSL443 53 x 8mm slat 443 mm long
- FBSL585 53 x 8mm slat 585 mm long
- FBSL640 53 x 8mm slat 640 mm long
- FBSL991 53 x 8mm slat 991 mm long
- 100 x 12mm profile
- FBSL1372 100 x 12mm slat 1372 mm long

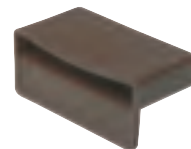

BED SLAT POCKETS



Hardwood bed slats

NEW BED SLAT END POCKETS

- FBSLPK538 Slat pocket for 53 x 8 slats
- FBSLPK112 Slat pocket for 100 x 12 slats



Bar Handle 12mm diameter 156mm long M4 mounting holes @ 96mm centres. Steel handle with stainless steel effect finish. Requires M4 handle screws to suit board thickness **FFBH156**



Matt Nickel Finish Bow Handle 96mm hole centres, 141mm length, 29mm high & 20mm wide. **FFBWH141**



NEW Bow Handle 128mm hole centres, 168mm length, 30mm high & 22mm wide. AS USED ON OUR NEW COMPACT TIP UP SINK AND CABINET. **FFBWH168SS** STAINLESS STEEL EFFECT **FFBWH168PC** POLISHED CHROME FINISH

WE NOW OFFER INSTALLATION SERVICE IN KENILWORTH BY SupremeTech.co.uk



LIGHTWEIGHT FURNITURE BOARD & WALLBOARDS

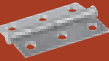

NEW LIGHTWEIGHT FURNITURE BOARD

When fitting out the furniture for the interior you require quality panels that look good, are impact resistant, but do not add excessive weight. Our lightweight ilomba faced plywood decorated with a durable hard face laminate weigh only 20Kg per board (based on 8' x 4' 15mm sheets).

Furniture board is available in 8' x 4' sheets 15mm veneered both sides and 3mm veneered one side. We also have a range of shower/wall board in various colours 8' x 4' sheets 3mm thick. We also have in stock plain poplar or far eastern ply in 3mm & other thicknesses.

We also have plain poplar or far eastern ply in 3mm & other thicknesses.

15MM BOARD DOUBLE FACED

FBD1584PUT	15mm Double sided Puntinella
FBD1584TNM	15mm Double sided Titanium
FBD1584WAL	15mm Double sided Walnut
FBD1584BCH	15mm Double sided Beech
FBD1584OAK	15mm Double sided Oak
FBD1584MPL	15mm Double sided Maple
FBD1584BRG	15mm Double sided Bright Grey
FBD1584CHY	15mm Double sided Cherry
FBD1584CBN	15mm Double sided Carbon (not pictured)

3MM BOARD SINGLE FACED

FBD0384PUT	3mm Single sided Puntinella
FBD0384TNM	3mm Single sided Titanium
FBD0384WAL	3mm Single sided Walnut
FBD0384BCH	3mm Single sided Beech
FBD0384OAK	3mm Single sided Oak
FBD0384MPL	3mm Single sided Maple
FBD0384BRG	3mm Single sided Bright Grey
FBD0384CHY	3mm Single sided Cherry

3MM WALLBOARD SINGLE FACED

FBD0384STL	3mm Single sided Stella
-------------------	-------------------------

3MM LIGHTWEIGHT PVC WALLBOARD

FBD0384WHT	3mm Lightweight PVC wall board ideal for showers being totally waterproof & easy to clean
-------------------	---

KNOCK IN T SLOT EDGE & PROFILES (PER METRE)

T edging is installed into routed slot in edge of board to provide a neat finish in furniture construction.

FBESLTBCH	SINGLE LIPPED T BEECH EFFECT
FBESLTDBRN	SINGLE LIPPED T DARK BROWN
FBESLTDGRY	SINGLE LIPPED T DARK GREY
FBESLTMGRY	SINGLE LIPPED T MID GREY
FBESLTSLV	SINGLE LIPPED T SILVER

LOCKER DOOR PROFILE (PER METRE)

Locker door edge profile with double lipped T.

FBELDPMGRY	LOCKER DOOR PROFILE MID GREY
FBELDPSLV	LOCKER DOOR PROFILE SILVER

SOFT TABLE EDGE B PROFILE (PER METRE)

Soft T edging installed into routed slot in edge of board to make up table tops.

FBESTEDGRY	SOFT TABLE EDGE 'B' DARK GREY
FBESTEMGRY	SOFT TABLE EDGE 'B' MID GREY

CORNER BOARD PROFILE (PER LENGTH)

Allows two board edges to neatly create a corner. Ideal for wardrobes, toilet shower room or wardrobes. Rigid profile with soft corner infill.

FBECORNMGY	CORNER PROFILE MID GREY 2.2MTR
FBECORNSLV	CORNER PROFILE SILVER 2.2MTR

WINNING POST SOFT TRIM (PER METRE)

Trim is pinned to edge of furniture where it comes into contact with shaped sidewalls to give a neat edge finish and take up any variances.

FBEWPTWHT	WINNING POST SOFT TRIM WHITE
FBEWPTMGRY	WINNING POST SOFT TRIM MID GREY
FBEWPTBGE	WINNING POST SOFT TRIM BEIGE

WALL BOARD JOINT AND EDGE STRIP (PER LENGTH)

FBWBEGTWHT	WALL BOARD EDGE TRIM WHITE
FBWBJNTWHT	WALL BOARD MID JOINT WHITE

NEW 6MM ARBOUR SLOTTOR TOOL

For grooving and milling of the slots for the T edging using a router with 6mm collet.

FBRTSLT16	1.6MM SLOTTOR CUTTER COMPLETE
------------------	-------------------------------



Puntinella



Titanium



Walnut



Beech



Oak



Maple

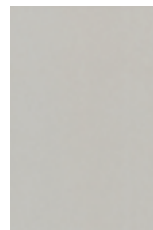

Bright Grey

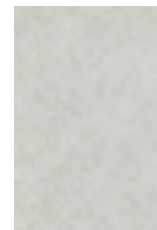

Stella Wallboard

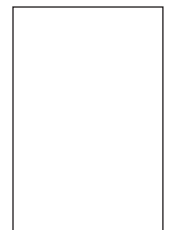

WHITE UPVC SHOWER WALL BOARD



Single lip T edge profile



Locker door edge profile



Soft table edge



WINNING POST SOFT TRIM



PLYWOOD 3.2mm EDGE TRIM



MID JOINT



CORNER BOARD PROFILE



PRE GLUED IRON ON EDGING



ROUTER SLOT CUTTER

NEW IRON ON EDGING

Edging easily installed using a domestic iron. Iron on with paper slipped between iron and edging to protect surface while bonding the pre coated hot melt glue.

FBEIRNALB	ALABASTER
FBEIRNBCH	BEECH
FBEIRNMPL	MAPLE
FBEIRNOAK	OAK
FBEIRNPNT	PUNTINELLA
FBEIRNWAL	WALNUT
FBEIRNCBN	CARBON

We have various other matching edging, T sections and profiles. Please check for current stock availability.



0844 414 2324



0844 414 2425

PUSH BUTTON DOOR LOCKS

Neat easy to fit push button lock. Press button to unlock, knob extends and door can be opened, Close door and push button until flush, catch clicks door is now locked and button stays Flush. When pressed home, the knob forms an attractive flush finish with the cupboard door. The push button lock is very easy to use and very reliable in operation.

The locks comprise of push-button lock case, rosette and push button. After locating the required lock position, a 26mm hole is drilled in the door. The push button lock case is fixed to the inside of the door by way of two screws through the casing tabs. The rosette is pushed Tight into the hole from outside, the knob is screwed on tight to the lock pin. The installation of just the push button lock case is suitable for all smaller cupboard and overhead locker doors. For larger doors such as wardrobes and toilet compartment doors the addition of a **hook rod set** is essential. This provides a three point locking set up to ensure the door is held tight. The three point locking will cut out the rattling of the door against the Frame, thereby making for a quieter journey.

SINGLE SIDED PUSH BUTTON LOCKS

Single sided button for cupboards and overhead lockers, Lock kit includes lock case, knob, rosette and striking plate. For use on long doors wardrobes etc add a **Hook Rod Set**. To fit a Hook Rod Set add **H** to the end of the lock order code (i.e. **FPLSBH**) to order lock with locating holes, then order the quantity of Hook Rod Sets required below.

- FPLSB** BROWN BUTTON SINGLE PUSH-LOCK (BROWN LOCK CASE)
- FPLSG** LIGHT GREY BUTTON SINGLE PUSH-LOCK (WHITE LOCK CASE)
- FPLSD** GOLD BUTTON SINGLE PUSH-LOCK (BROWN LOCK CASE)
- FPLSN** MATT NICKEL BUTTON SINGLE PUSH-LOCK (BROWN LOCK CASE)
- FPLSW** WHITE BUTTON SINGLE PUSH-LOCK (WHITE LOCK CASE)

DOUBLE SIDED PUSH BUTTON LOCKS

Double sided button for toilet/ bathroom where lock needs to be operated from both sides, for use on long doors add a Hook rod set. Kit includes: lock case, 1 x inner knob, 1x knob and rosette to colour and striking plate. The inner knob is supplied the same colour as the lock case.

- FPLDB** BROWN OUTSIDE BUTTON DOUBLE PUSH-LOCK (BROWN LOCK CASE)
- FPLDG** LIGHT GREY OUTSIDE BUTTON DOUBLE PUSH-LOCK (WHITE LOCK CASE)
- FPLDD** GOLD OUTSIDE BUTTON DOUBLE PUSH-LOCK (BROWN LOCK CASE)
- FPLDN** MATT NICKEL OUTSIDE BUTTON DOUBLE PUSH-LOCK (BROWN LOCK CASE)
- FPLDW** WHITE OUTSIDE BUTTON DOUBLE PUSH-LOCK (WHITE LOCK CASE)

HOOK ROD SETS

Hook rods are added to provide 3 point locking of larger doors (wardrobes and washrooms etc.) to reduce vibration noise and secure door more firmly. Kit includes: 2 x catch hooks, 2 x 1000 mm rods with PVC over sleeve tubes and 2 x locking bolts. Rods and over sleeves can cut down to size.

- FPLHRB** HOOK ROD SET 2 x RODS + BROWN PVC OVER SLEEVE, 2 x LOCK BOLTS & CATCH HOOKS

MINI PUSH BUTTON LOCKS

New mini single button push lock for small cupboards and overhead lockers

- FPLMD** GOLD BUTTON MINI PUSH-LOCK (BROWN LOCK CASE)
- FPLMN** MATT NICKEL BUTTON MINI PUSH-LOCK (BROWN LOCK CASE)

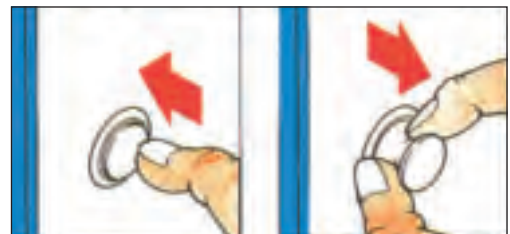
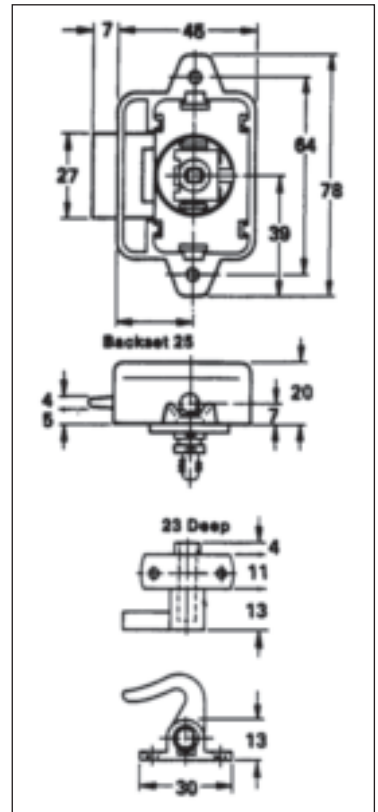
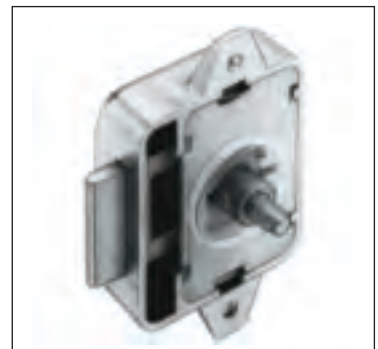

NEW MINI PUSH-LOCKS

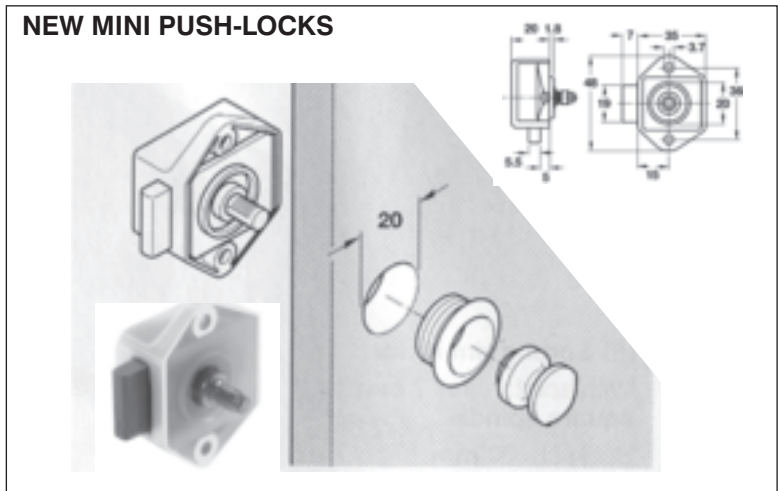

WE NOW OFFER INSTALLATION SERVICE IN KENILWORTH BY SupremeTech.co.uk

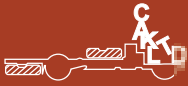

FURNITURE FITTINGS & ACCESSORIES



Use colour code after product code replace + with colour. Colours: BG = BEIGE, BR = BROWN, K = BLACK, W = WHITE, OW = CREAM.

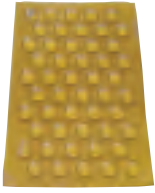

Each door should be fitted with 2 silicon buffers to silence the closing action and eliminate vibration to protect the door and cabinet from damage.
FFSDB50 SILICONE DOOR BUFFERS PK 50



FF6823.. Wardrobe rail support for 15mm tube



B6832 ADJUSTABLE TURN BUTTON CATCH WHITE 25 – 45MM RATCHET ACTION LOCK

B6832 The adjustable turn button will retain a shower door or other objects between heights of 25mm x 45mm. The ratchet mechanism is similar that of a cable tie and once pushed down over the barbs will lock the retainer. To release the mechanism you simply turn the retainer 90 degree and slide the collar out, turn it 90 degree over the door and push down to ratchet and lock.



FFRCSINW SINGLE ROLLER CATCH WHITE



FFMG1W MAGNETIC CATCH WHITE
FFMG2B MAGNETIC CATCH BROWN



FPORPT

CARRIER BAG BIN HOLDER

Wall mounting bracket to use shopping bags as a waste bin. Arms fold out for good access and fold closed to retain contents in bag. Fixed to wall or inside cupboard door by 2 screws. 300mm Long protrudes 15mm when closed.

FPORPT Plastic bag waste bin holder

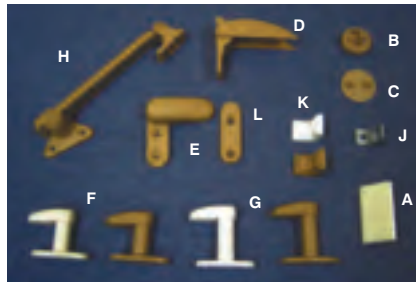

- A **B6306+** Corner joint double (W, BG)
- B **B6308BG** round knock down panel fitting (BG)
- C **B6309BG** round kd panel fitting cap (BG)
- D **B6806+** sink top flap retainer (BG, W)
- E **B6834BG** turn button catch (BG)
- B6835BG** 10mm spacer for B6834BG
- L **B6836BG** Beige striker for B6834BG
- F **B6840+** collared turn button c/w base 26 mm (BG, W)
- G **B6841+** collared turn button c/w base 35 mm (BG, W)
- H **B6876+** collared turn button c/w base 45 mm (BG, W)
- K **B6862BG** adjustable locker stay single (BG only)
- J **B8043** 1 x 1 diecast zinc bracket pack of 10
- K **B8044+** 1 x 1 bracket cover pack of 10 (BG W)



FFRCW Twin roller V catch white



FFMLB Mini Latch plated with brown keep

FFMLW Mini Latch plated with white keep

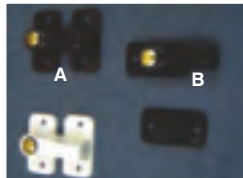

DC1005

DC1021



Turn buckle catches DC1005 shown with DC1021 dimensioned right, is a neat twist catch for retaining internal doors & flaps etc. Brown, Black & White.

- A **DC1005** Turn buckle catch (BR, BK, W)
- B **DC1021** Plate for DC1005 catch (BR, BK, W)

- DC100918** Heavy duty turn buckle catch with support leg Black
- DC100910** Turn buckle catch 18 mm
- DC1025** Turn buckle catch 10 mm Plate for DC1009++ catch.



DC100918

DC100910



DC719W Sprung door catch (W)



B6804+ Adjustable sink flap retainer (BG, W)



MAGAZINE NET

A neat storage pocket for books & papers etc. 215 mm high x 315 mm wide.

Colour: Black

BMAGNT MAGAZINE NET BLACK

CONTINENTAL STYLE DOOR CATCHES

Designed for installation in double faced lightweight ply for simple access doors.

Square door catch for 45mm dia hole fits 12 to 20mm thick panel.

DH105B BROWN (A)

DH106G GREY (B)

Profile 2000 Square door catch fits 50 X 50mm cut out for 15mm ply

DH430LG LIGHT GREY (C)



- B6813+** Table stowage bracket (BG,G,OW,W)
- B6814+** 5mm spacer for B6813 (BG,G,OW,W)
- B6815+** 10mm spacer for B6813 (OW,)

Neat and effective press to open drawer catch
DH2029N Slim drawer catch colour matt silver
DH2037 Catch plate for DH2029

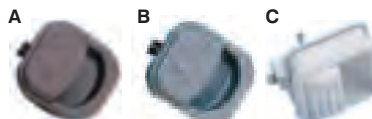

WE NOW OFFER INSTALLATION & REPAIR SERVICE BY SupremeTech.co.uk



0844 414 2324



0844 414 2425

BARKEEPER CUPBOARD CONTENTS RETAINERS

We have all experienced opening cupboards after traveling to have the contents fall out. Particularly cupboard above the hob where items falling out can easily break glass hob top or put a hole in the work surface. It happened to us so we came up with a solution.

New Barkeepers are designed to easily adjust to fit tightly any cupboard shelf to prevent the contents launching out at you when opening the door.

The Barkeepers come in several widths and coating finishes. They are easily and quickly adjusted to fit tightly into width or height of cupboard, while being easily removed to gain access. Simply squeeze adjustable tube between to release, rubber end caps ensure the Barkeeper grips securely into cupboard to retain contents.

Manufactured from Aluminium or Steel to ensure robustness & plastic coated in white or attractive wood effects.

BARKEEPER

- FBK11300 BARKEEPER WHITE 25-44 cm
- FBK11310 BARKEEPER WHITE 41-71 cm
- FBK11400 BARKEEPER OAK 25-44 cm
- FBK11410 BARKEEPER OAK 41-71 cm
- FBK11500 BARKEEPER PINE 25-44 cm
- FBK11510 BARKEEPER PINE 41-71 cm

- FBK11321 BARKEEPER XXL ALU WHITE 48-80 cm



WHITE



OAK



PINE



NEW TOP LOCKER DOOR SUPPORT STAYS

New high quality metal support stays for upward opening top locker doors. The stays function like car tailgate rams but use a compressed spring within its casting to support the door. The 150mm size is the most popular in the range. Larger sizes suit the larger overhead locker door.

- FTLSTM150 LOCKER STAY 150 mm MOST POPULAR SIZE
- FTLSTM200 LOCKER STAY 200 mm
- FTLSTM250 LOCKER STAY 250 mm

TOP LOCKER DOOR SUPPORT STAYS

A SIMPLE SPRUNG STAY WITH ACETAL BODY. SPRING IS COMPRESSED BY ACTION OF OPENING OR CLOSING DOOR

- FTLSTP100 ACETAL SPRUNG LOCKER STAY 100 mm
- FTLSTP120 ACETAL SPRUNG LOCKER STAY 120 mm



FTLSTP100

FTLSTP120



TOP LOCKER HINGE

Hinge specially designed for top locker doors. Hinge has built in sprung snap action to hold open locker door without the need for installation of side stays.

- FTLH1 Top Locker Hinge



FTLH1



FPOR TV8083

SIMPLE LCD TV MOUNTS

Fixed TV mount slides onto wall bracket allowing easy stowing of TV if required. Max load = 10KG

- FPOR TV8082 LCDTV fixed wall mount
- FPOR TV8083 LCDTV swivel wall mount

- FPOR TV8082



Rear view showing wall mounted bracket, allowing easy removal from wall

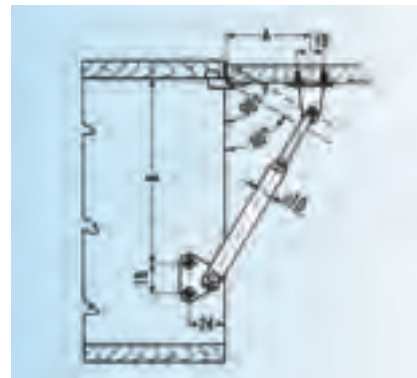

	mm 150	mm 200	mm 250
∅	40	40	40
A mm	80	110	150
B mm	110	130	150
C mm	80	80	80
D mm	30	30	30
E mm	120	140	140

TOP LOCKER GAS SPRING SUPPORT

Gas spring specially designed for top locker doors. Supplied with several alternative end knuckle fittings to suit optimum fitting position. Struts have force ratings (60N is 60 Newton's force) as printed to their side to identify load capacity. As used by many continental manufacturers.

- FTLS205460 60 Newton gas spring locker support stay
- FTLS205480 80 Newton gas spring locker support stay



FTLS205460

NARROW SLIDE OUT LCD TV SUPPORT

New narrow slide out TV support is ideal to install in narrow cupboards. Support arm rotates and inclines to allow ideal positioning for viewing. Narrow design and rotating arm allows TV to be stowed narrow way into cupboard allowing more room for DVD, satellite, or Freeview boxes. Cassette slide extends 40cm. TV capacity 20kg.

- FPOR TV6101



ADJUSTABLE LCD TV MOUNT

Friction hinge at base of arm. TV mounting plate on arm is adjustable in height. Arm length 270mm max. Universal LCD TV mounting plate adjustment -40mm.

Can be fitted to conventional TV swivel to upgrade to an LCD TV

- FPOR TVL01



FPOR TVL01

WE NOW OFFER INSTALLATION SERVICE BY SupremeTech.co.uk



TV BRACKETS & SWIVELS

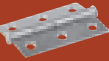

LCD TV / MONITOR WALL SLIDE MOUNT

New specially designed LCD slide out TV swivel. Mounting plate is made to international standard to be universal fit on LCD TV'S. High quality construction powder coated steel in light grey colour. 3 X High quality ball slide construction for smooth movement in and out. Safety catch locks unit in stowed position when TV support is pushed back into closed position.



LCD TV / MONITOR SLIDE OUT SWIVEL

New specially designed LCD slide out TV swivel. Mounting plate is made to international standard to be universal fit on LCD TV'S. High quality construction powder coated steel in light grey colour. High quality ball slide construction for smooth movement in and out. Safety catch locks unit in stowed position when TV support is pushed back into closed position.



Our Lightweight TV mounting fixes to sidewall of TV cabinet or suitable wall surface. The telescopic multi leaf slide extends from 350mm to 800mm. This can easily be shortened by removing or shortening the runners. LCD TV mounting plate swivels all the way around to enable TV to be viewed from either side. Mounting also has vertical adjustment for angle of viewing. Manufactured from anodized Aluminium profiles for strength while being light in weight. **FPTV810** Telescopic LCD TV Mount for smaller LCD TV'S

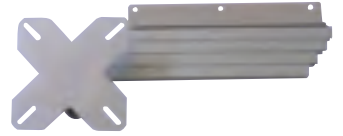

Not to be used extended while vehicle in motion.



TELEVISION / MONITOR SLIDE OUT SWIVEL

High quality ball slide construction for smooth movement in and out. Powder coated steel in light grey colour. Two sizes of extension are available. Safety catch locks unit in stowed position when TV support is pushed back into closed position. These TV swivels can be adapted to take LCD TV'S. Dimensions A width, B depth closed, C depth open.

FPORTV3 A: 290 B: 300 C: 623 FPORTV2 A: 265 B: 250 C: 458

FPORTV3 TV swivel slide out 29 x 29 cm

FPORTV2 TV swivel slide out 25 x 26 cm

TELEVISION / MONITOR SLIDE OUT SWIVEL SUPPORT

Sizes: 331 mm (13") wide, 330 mm (13") deep and extends 267 mm (10 1/2") approx. Colour finish: black plated.

FPORTV TV / monitor slide out swivel mechanism

NEW UNDER CABINET FLIP DOWN LCD SCREEN MOUNT

Designed for LCD / TFT Screens up to 17" with either 50mm, 75mm or 100mm VESA® fixings. Max Screen Weight: 10Kg. Simple slide-out and flip-down action, 360° swivel and tilt function allow for optimum viewing, Max Screen size 17" (subject to space allowed), Pivot: 360 degree's, Tilt: +/- 15 degree's.

FPORTV7525W FLIP DOWN LCD SCREEN MOUNT WHITE

NEW LCD TV / MONITOR MOUNTING BRACKET

LCD wall-mounting bracket mounts the screen only 20mm from the wall its ideal for wall mounting computer monitors in mobile offices, hospitality units and TV broadcast units. Screen size from 10" to 23" and weight up to 20Kg.

FPORTV7510K LCD FIXED WALL MOUNT BLACK

FPORTV7510SG LCD FIXED WALL MOUNT SILVER GREY

NEW LCD TV / MONITOR TILTING WALL MOUNTING

This mount permits the wall-mounted installation of LCD TV'S in Motorhomes, Caravans & Specialist Vehicles. Screen size from 10" to 23" and weight up to 20Kg, mount has a tilt range of 17° (this may be limited due to the size of your screen) and mounts the screen only 55mm from the wall. Unique security screws with long hex key help prevent theft.

FPORTV7511K LCD TILTING WALL MOUNT BLACK

FPORTV7511SG LCD TILTING WALL MOUNT SILVER GREY

NEW LCD TV / MONITOR WALL ARM MOUNT

New design LCD TV wall bracket. Mounting plate to fit LCD TV'S from 10" to 23" and weight up to 15Kg. Arm that allows the screen to be mounted only 75mm from the wall or extended up to 280mm. Two swivel points - one at wall for 180°, one at the screen of 240° & a tilt function of up to 17° (this may be limited due to the size of your screen).

FPORTV7512C SINGLE ARM MOUNT CHROME (LTD STOCK)

FPORTV7512K SINGLE ARM MOUNT BLACK

NEW SWING OUT LONG TWIN ARM LCD MOUNT

Designed for LCD Screens from 10" to 23" and weight up to 15Kg. The twin arm design allows full flexibility, it can mount the screen flat to the wall or extend out to up to 450mm from the wall. 3swivel points - one at the wall for 180°, one in the middle of 240° and one at the screen of 240° also has a tilt function of up to +/- 17°.

FPORTV7513K TWIN ARM MOUNT BLACK

NEW LCD TV / MONITOR PIVOT WALL MOUNTING

Pivoting wall mount for screen size from 10" to 23" and weight up to 20Kg, mount has a tilt range of 17° & 180° swivel (subject to size of screen) and mounts the screen only 95mm from the wall.

FPORTV7518K LCD PIVOT WALL MOUNT BLACK

FPORTV7518SG LCD PIVOT WALL MOUNT SILVER GREY

LCD TV / MONITOR SWING DOWN CEILING MOUNT

New design LCD TV swing down bracket with lock to stow TV up at ceiling. Mounting plate is made to international standard to be universal fit on LCD TV'S. High quality powder coated steel in light grey colour.

FPORTV13 LCD TV ceiling mount

FPORTV7525SG



FPORTV



FPORTV7510

FPORTV7511



FPORTV7518

FPORTV7512

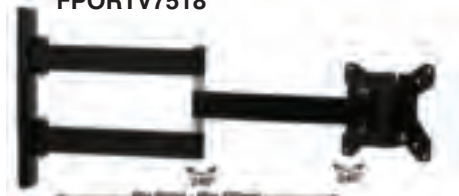

FPORTV7513



FPORTV13

SEE NEXT PAGE FOR MORE TV MOUNTS

WE NOW OFFER INSTALLATION & REPAIR SERVICE BY SupremeTech.co.uk



0844 414 2324



0844 414 2425



TABLES FITTINGS AND ACCESSORIES



Furniture Fittings - Tables

NEW FOLDING SHELF SUPPORT

Our new simple but effective shelf support is high on performance and low on cost. Available in 3 sizes and 2 colours. Simple locking and folding action provides an easy to use strong and effective support to add worktop extensions or small tables. Size A open. Size B closed 35 mm.

- FSS6200BR** Folding shelf support 200mm brown
- FSS6200BL** Folding shelf support 200mm black
- FSS6300BR** Folding shelf support 300mm brown
- FSS6300BL** Folding shelf support 300mm black
- FSS6400BR** Folding shelf support 400mm brown
- FSS6400BL** Folding shelf support 400mm black



NEW SELF LOCKING SHELF SUPPORT

New automatic locking shelf support, lift up and it clicks into position. To lower just lift the front lever to release lock and lower it down.

- FSB1851BL** 185mm Self Locking Shelf Support
- FSB2852BL** 285mm Self Locking Shelf Support
- FSB3403BL** 340mm Self Locking Shelf Support



SWING OUT FLAP SUPPORT

- B6302BG** Swing out, flap support bracket

TABLE HOOK

Nylon fitting allowing one end of small tables to be attached to wall. Table will also require a table leg. Colour available BR= Brown

- TF3001BR** Neat and effective table hook.

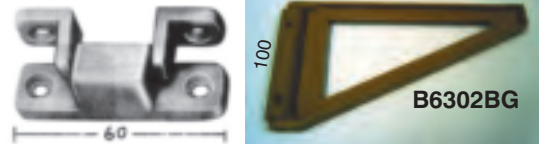

FOLDING FLAP/ SHELF SUPPORTS

The new supports for drop leaf shelves provide valuable worktop space. While being easily folded away.

- TSMN345** 345 mm folding flap support mechanism
- TSMN445** 445 mm folding flap support mechanism
- TSMN8098** Heavy duty folding shelf support mechanism
- TSMN30500** Very strong 3 part folding support mechanism

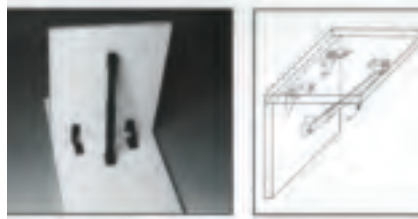

TSMN30500



TSMN445



TSMN345



TSMN8098

FOLDING SPRUNG FLAP SUPPORTS.

Easy to operate spring lock location of support arm. Made from strong pressed steel, zinc plated and passivated.

- TSMN250** 250mm folding sprung flap support mechanism
- TSMN380** 380mm long folding flap support



TSMN250

Simple version PMT allows table to be rotated 360 degrees and locked in position. The top allows table to be slid long ways 25cm and width ways 14cm. Black coated steel.



FIXED POLE HEAVY DUTY TABLE SUPPORT

Fixed table support is manufactured from a zinc plated core with an outer grey plastic tubular cover for a smart installed appearance. Fixed table height 720mm.

Available with version PMT sliding top frame.

- TSL612400PMT** Fixed table support top version PMT



TVSV5



TSL612400PMT

NEW LCD TV WALL MOUNTS

The Svensen **TVSV5** Quick Release Wall Mount is a secure mounting point for your flat screen television. The mount supports 10" to 23" screens up to 25Kgs.

NEW UNDERSHELF TV MOUNT

The Svensen **TVSV6** Undershelf Bracket is a sturdy, easy to install mount for your LCD or LED TV. Its fold-away arm conceals the display beneath your cabinet until you want to use it. An integrated swivel mount allows you to rotate the screen for easy viewing from any angle.

NEW ADJUSTABLE SWING ARM TV MOUNTS

The Svensen Adjustable Swing Arm is a sturdy, easy to install mount for your LCD or LED TV. A built-in spirit level and simple 3-point wall mounting makes fitting the arm easy. The slide-in TV attachment can be locked for security and allows quick screen removal without tools.

- TVSV7** Short Adjustable Swing Arm
- TVSV8** Single Adjustable Swing Arm
- TVSV9** Double Adjustable Swing Arm

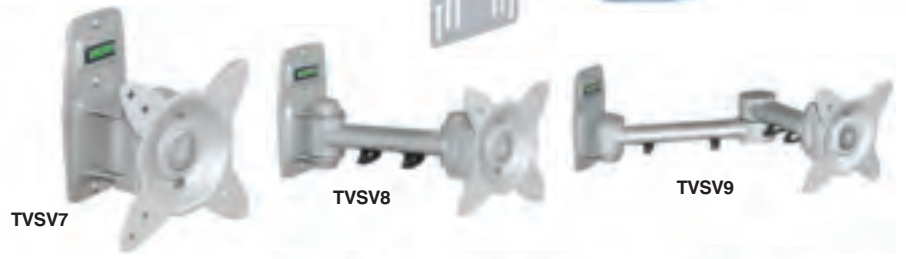

TVSV7

TVSV8

TVSV9

LCD TV / MONITOR MOUNTING BRACKET

Our LCD wall-mounting bracket permits the wall-mounted installation of LCD TV'S in Motorhomes, Caravans & Specialist Vehicles. It is ideal for wall mounting computer monitors in mobile offices, hospitality units and TV broadcast units.

- FPORTVL** LCD TV wall mounting bracket

Swing out arm LCD TV mount. Swing out has lock points at stowed and 90 degree open, additional positions can be cut into runner for precise positioning. Dual direction adjustment on LCD TV mounting plate. Fixing bracket 180mm H x 80mm. Arm pivot 220mm centres.

- FPORTV09** Swing out arm LCD TV wall mount



FPORTVL

FPORTV09

WE NOW OFFER INSTALLATION SERVICE BY SupremeTech.co.uk



TABLES FITTINGS AND ACCESSORIES



TSCNAUT

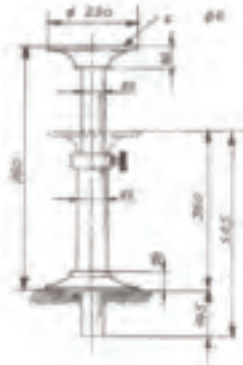

TELESCOPIC ISLAND TABLE POLE

New smart & stylish table support raises and lowers to suit height required. Strong marine grade castings top and bottom for strength. Matt anodised aluminium pole provides a quality finish to the leg. Table can be positioned at any height with the clamp knob. The mounting bases are 220mm Ø with recessed fixing holes providing a very sturdy table. The table pole has a maximum height of 760mm. Its height with the pole retracted to touch floor surface is 500mm. The table pole is designed to retract into a hole through the floor, where it is fitted with this hole the pole will retract to 362mm high, the pole will project through the floor 138mm.

TSCNAUT TELESCOPIC ISLAND TABLE POLE

FREE STANDING LOWERING TABLE FRAME

Complete portable freestanding table support with height adjusting Folding action. This enables the table to be used as a normal height Dining table or lowered to support a bed or act as a coffee table. Being completely portable it can also be used outside. (Colour brown) New narrow version 620mm wide for the smaller conversion space. Max height 655-> 695mm, minimum height 300 -> 340mm.

TSFSARB62 Free standing lowering table frame 620mm wide
TSFSARB76 Free standing lowering table frame 760mm wide

TELESCOPIC ELECTRICALLY OPERATED TABLE SUPPORT

Telescopic table support is manufactured in steel with a stylish moulded plastic nesting skirt to hide mechanism. The table is powered by a 12v electric actuator controlled by remote wall switch which is supplied in kit. Table support is supplied complete with 2 way sliding mechanism for precise positioning of table top. (Table top is not supplied only fitted for photo demonstration) Height of leg max 720mm min 330mm

TSE612300TA Telescopic electric table support grey top A
TSE612300TB Telescopic electric table support grey top B width ways.

TELESCOPIC GAS STRUT OPERATED TABLE SUPPORT

Telescopic table support is designed to automatically raise from low to high by the press of the foot operated button on the floor base. Table locks in upper position until foot operated button is pressed to release lock. Hole in floor 100mm dia by 40mm deep for base of mechanism to fit into floor. Max frame height 765mm min height 345mm.

TSM612500TA Gas strut operated table support top version A
TSM612500TB Gas strut operated table support top version B



TSM612500

TSM612300 IN LOWERED POSITION

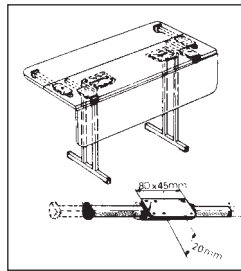

TSFSARB76



TSCR

SLIDING SUPPORTS FOR DROP LEAF TABLE TOPS

The sliding supports allow drop leaf tables to be used, freeing up valuable storage space. Can also be fitted inside a cupboard to pull out and support a fold over worktop.

TSCR250 250 mm sliding support 150 mm of slide
TSCR300 300 mm sliding support 200 mm of slide
TSCR350 350 mm sliding support 250 mm of slide

HIGH SPEC FIXED, MANUAL & ELECTRIC TABLE SUPPORTS

Top slides pictured below are only supplied as part of the table kits left.

TABLE SLIDE TOP FRAME VERSIONS

Traversing positioning slide frame can be locked in any position it is slid to by means of tightening clamp levers on the slides. Available in 2 versions.

Version A allows table to be located on centre plate in 4 positions before it is bolted on. High quality aluminium slide rails allow positioning of table with ease. The slide mechanism allows 0 - 36cm slide able long ways and 0 to 17cm slide able width ways.

Version B allows table to be rotated fully 360 degrees and used in any positions by means of a swivel plate mechanism similar to a set swivel plate. It is lockable in 4 positions. High quality aluminium slide rails also allow positioning of table with ease. The slide mechanism allows 0 - 36cm slide able long ways and 0 to 17cm slide able width ways.



Version A



Version B

WE NOW OFFER INSTALLATION SERVICE BY SupremeTech.co.uk



0844 414 2324



0844 414 2425



TABLE FITTINGS & ACCESSORIES



Furniture Fittings - Tables

THE HOOK N' LOCK TABLE WALL SLIDE BAR.

LOCKED TRAVELLING POSITION

OPTIONAL POSITIONS

DISMOUNTED

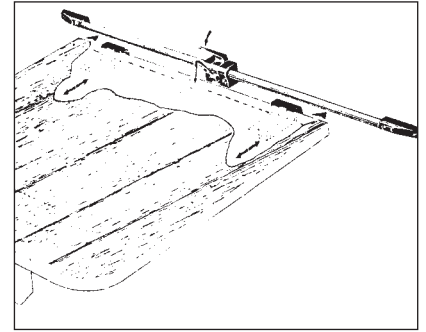
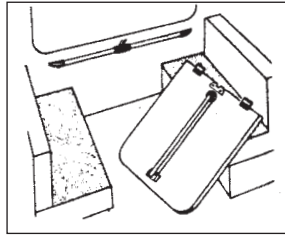
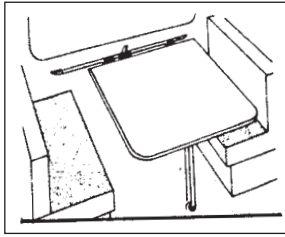
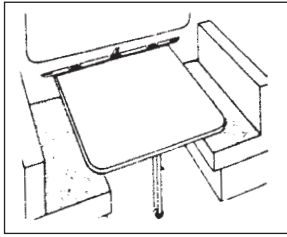

The hook n' lock is designed to firmly fix table to sidewall, while allowing lateral movement when unlocked, to make access to bed boxes easier, simply press down on central lock arm to release lock and slide table away without disturbing items on top of the table. Designed to complement our swing n' lock folding table leg to make up table. Securely anchors table for traveling and use while allowing the flexibility of position.

- TS950** Hook n' lock table slide bar 950mm long kit
- TS1BK** Spare set of table fixings to add alternative table to hook n' lock

ISLAND LEGS

Range of island table legs and fittings to make strong tables. Tabletop can be used and fitted 360 degrees. A single leg will suffice for tables up to 20 inches square. For the larger table 20 x 24 inches upwards a pair of legs must be used. Available as individual components or as sets see price list for details. Colour options: Add B to end of code for Brown, BL for Black & C for chrome legs and polished aluminium bases. . Stainless Steel 700mm legs only available as sets, 355mm leg sold singly.

- TS14SS** Island table leg 14" (355mm) (STAINLESS ONLY) For bed support
- TS126** Island table leg 26" (660mm)
- TS128** Island table leg 28" (710mm) (700mm Chrome)
- TSBAF** Above floor base
- TSBRC** Recessed base
- TSSET26B** Set of 660mm 26" island leg, above floor & recessed base BROWN
- TSSET28B** Set of 710mm 28" island leg, above floor & recessed base BROWN
- TSSET26BL** Set of 660mm 26" island leg, above floor & recessed base BLACK
- TSSET28BL** Set of 710mm 28" island leg, above floor & recessed base BLACK
- TSSET28C** Set of 700mm 27 1/2" CHROME island leg, above floor & recessed base
- TSSET28SS** Set of 700mm 28" Stainless Steel island leg, H Duty Cast Ali above floor & recessed base
- HTC200B** 51mm Island leg storage spring clip black coated

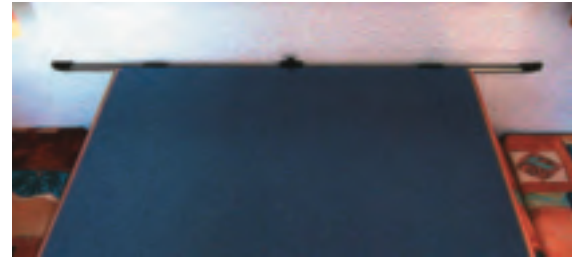

TS950

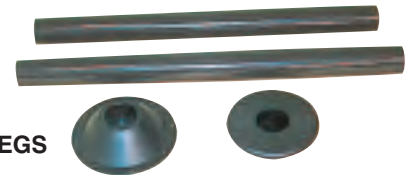

ISLAND LEGS

SWING N' LOCK FOLDING TABLE LEG

Robust folding table leg can be used in many applications used in pairs to make a free standing table or use with hook n' lock table slide to make variable position table.

Colour options: Add B to end of code for Brown or add G for Grey or SS for Silver Sand

- TSLF26-** Swing n' lock folding table leg 660 mm
- TSLF28-** Swing n' lock folding table leg 710 mm

LIGHTWEIGHT FOLDING TABLE LEGS

High quality oval aluminium tube table legs. Lightweight and strong modern design. Innovative knuckle hinge for strength and reliability. 50mm x 25mm oval tube 715mm high. Kneeling height 325mm is used to make up bed base. New version with base bar to add further stability to tables over 600mm wide

- TS8350B** Kneeling half folding table leg brown
- TS8350G** Kneeling half folding table leg grey
- TS8376G** Kneeling half folding + base bar table leg grey
- TS8050B** Full folding table leg brown
- TS8050G** Full folding table leg grey
- TS8376G** Full folding table leg black + base bar with wheels for easy Movement of table along Hook N' Lock or TS2000 table bar.

SWING 'N' LOCK

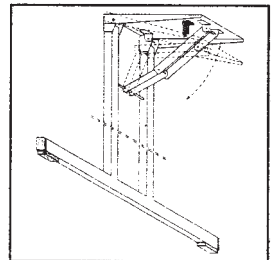

SWING 'N' LOCK

BIFOLD N' LOCK FOLDING TABLE LEG

Robust BI folding table leg can be used in many applications used in pairs to make a free standing table or use with hook n' lock table slide to make variable position table. Leg when folded reduces in size in a scissor action to allow smaller table tops and reduced storage space requirements Colour Black.



- TSLF650K** Bifold n' lock folding table leg 650 mm



TS8050 TS8350 LIGHTWEIGHT FOLDING TABLE LEGS

TS8376

WE NOW OFFER INSTALLATION SERVICE IN KENILWORTH BY SupremeTech.co.uk